

## SCIENCE OF TSUNAMI HAZARDS

Journal of Tsunami Society International

Volume 33

Number 3

2014

### NOVEL TSUNAMI BARRIERS AND THEIR APPLICATIONS FOR HYDROELECTRIC ENERGY STORAGE, FISH FARMING, AND FOR LAND RECLAMATION

**Hans J. Scheel**

Scheel Consulting, CH-8808 Pfäffikon, Switzerland  
[hans.scheel@bluewin.ch](mailto:hans.scheel@bluewin.ch) [www.hans-scheel.ch](http://www.hans-scheel.ch)

#### ABSTRACT

The tsunami hazard can be mitigated if the destructive waves generated from earthquakes and landslides can be reflected by a stable submerged vertical barrier before striking coastal communities or important structures. Building such deep walls by conventional submarine technology is difficult. The present study describes the principle and the erection of such submarine defensive walls by a relatively simple efficient and economic technology. This technology is based on lowering high-strength steel fences with horizontal anchors, or two parallel steel fences with distance holders, into the sea and fixing them with rocks deposited from top. Dredged material like gravel or sand can be used for additional filling. This Tsunami-Flooding Barrier (TFB) extends a few meters above sea level and carries on top a concrete supply and service road protected on both sides against storm waves by concrete walls. Replaceable surge stoppers (parapets, wave return walls) prevent overtopping and erosion of the seaward barrier face. The TFBs protect the coastline against tsunami and the highest storm waves from hurricanes, but also can provide protection from oil spills or other contaminations from the ocean and thus protect flora, fauna, coral reefs and beaches. Channels and gates allow navigation and can be closed quickly upon a tsunami or storm warning.

The construction costs can be eventually compensated by using the reservoirs between coast and barriers for hydroelectric energy storage (using pump-turbines in the barriers) or for fish-farming, or alternatively the reservoir can be filled with rocks, rubble, gravel, sand and covered with soil in order to reclaim new land. Tidal energy can be generated by installing turbines within these barriers.

Also, this submarine architecture may be applied to protect pillars of bridges and offshore platforms, and for erecting “roads” into the sea to connect near-shore platforms and wind-parks with the coast and additionally include oil, gas, gasoline pipelines and electricity lines.

**Keywords:** Tsunami and flooding barrier, hydroelectric energy storage, fish-farming, tidal energy, land reclamation, submarine architecture

## INTRODUCTION

Tsunami and flooding catastrophes have increased with time because the coastal population density has increased and because the number and intensity of tropical storms have increased, presumably due to climate change (Rauch 2014). The most recent destructive events were the 2004 Indian Ocean tsunami with more than 200,000 people killed and the March 11, 2011 Tohoku tsunami with about 20,000 fatalities – the latter with collateral, long term consequences from the Fukushima-Dai-Ichi nuclear power plant catastrophe. Major flooding catastrophes caused by hurricane Katrina 2005 in Louisiana, by Sandy 2012 in New York / New Jersey and by typhoon Haiyan 2013 in the Philippines had caused together 8,500 fatalities and damages of 179 billion USD. Fortifications at the coast and even the largest breakwaters could not withstand the enormous forces of overtopping tsunami and storm waves (Takahashi et al. 2000) - as will be specifically discussed with the example of the world’s largest breakwater at Kamaishi bay.

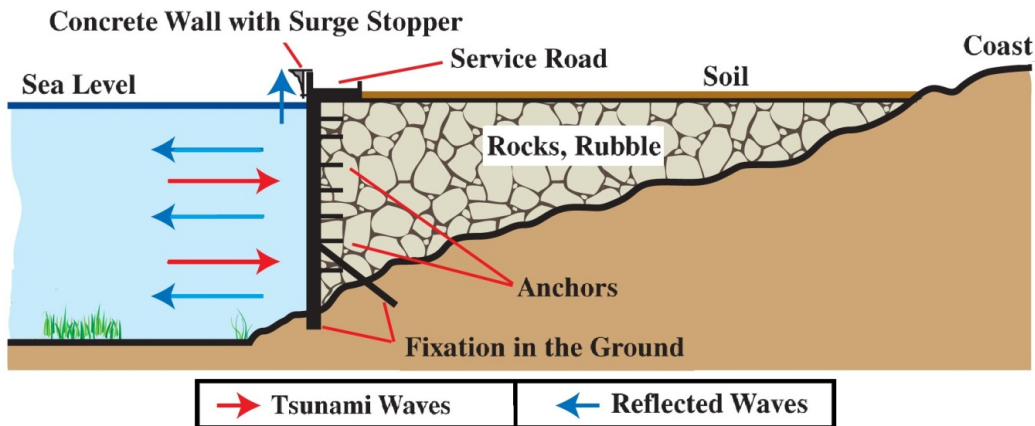
Bryant (2008) has given an overview about the tsunami hazard and specifically discussed the risk for large cities with population above 15 million like Los Angeles, Mumbai, New York, Osaka and Tokyo, for more than 50 cities with population of more than 2 million people, and for many coastlines. Hopefully there will be no temporal and geographic coincidence of a mega-tsunami with a hurricane/cyclone, which would cause immense fatalities and damage. The expensive tsunami warning systems summarized by Annunziato et al. (2012) and a fast tsunami assessment modeling system (Annunziato 2007) will in case of timely warning reduce the loss of lives, but cannot prevent the huge coastal damages. The historical data of NOAA/NGDC (2014) and predicted probabilities of recurrence (Potter 2013) will indicate the urgency of definitive installation of tsunami and flooding protection systems.

Levin and Nosov (2009) presented the physics of tsunami and Strusinska (2011) reviewed in her thesis recent investigations about tsunami wave characteristics and countermeasures. Coastal protection structures were reviewed by Burchardt and Hughes (2011), whereas Takahashi (2002) presented construction and stability features of partially vertical breakwaters. Srivastava and Sivakumar Babu (2009) had proposed a reinforced vertical earth wall to protect against tsunami which however will have little effect as will become clear below.

Effective tsunami protection barriers and their efficient and economic construction have been described previously (Scheel 2013.a, 2014.a, b). Extended vertical barriers along coastlines will not only protect lives and properties, but also have great advantages, which eventually will compensate for the construction costs by projects such as the proposed hydroelectric energy storage which uses huge seawater reservoirs near the coast and pump-turbines inside the barriers. Potential additional benefits could be the generation of tidal and wave energy, land reclamation and large-scale fishing farms.

## Reflection of Tsunami Impulse Waves at a Submerged Vertical Wall

Both tectonic and landslide generating mechanisms generate tsunami waves that have small heights and therefore are not detectable in the open sea. However, when these waves approach the shallow water depths of the coastal region, they can often increase greatly in heights of up to 40 m and become extremely catastrophic. The new approach described by this study and as schematically illustrated by **Fig. 1**, is to reflect the energy of these waves by a stable vertical wall before they reach maximum heights. The space between the barrier and the coast can be filled up to reclaim new land and to provide infinite stability to the barrier. Ideally, this reflecting wall should be installed in front of the break of the continental shelf where the slope of the seafloor is reduced significantly, typically at a water depth in the range of 200 m to 500 m. However, such deep vertical walls would be too difficult to construct and too expensive. In order to derive a compromise of safety and economy, the tsunami wave height as a function of water depth has to be evaluated. In the following first approximation the sea floor is assumed to be flat at 4000m depth and has constant slopes towards the coast, thus the bathymetric roughness (Holloway, Murty and Fok 1986), friction effects and sea bottom ridges acting as waveguides (Marchuk 2009) are neglected.



**Figure 1. Schematic cross section of a vertical wall which reflects the tsunami impulse waves. The gap between wall and coast is filled up for land reclamation**

The initial wavelength of tsunami impulse waves is much longer than the typical depth of the ocean of 4km, the amplitude of the waves is small, typically a few tens of centimeters, and the velocity is about 700 km per hour. As it is well known, when a tsunami wave reaches the decreased water depth near the coast, both its wavelength and its velocity are reduced and compensated by increased amplitude according to the law of energy preservation. The speed  $c$  of the tsunami wave in the deep ocean is can be approximated by the shallow water equation given by:

$$c = \sqrt{g \times h}$$

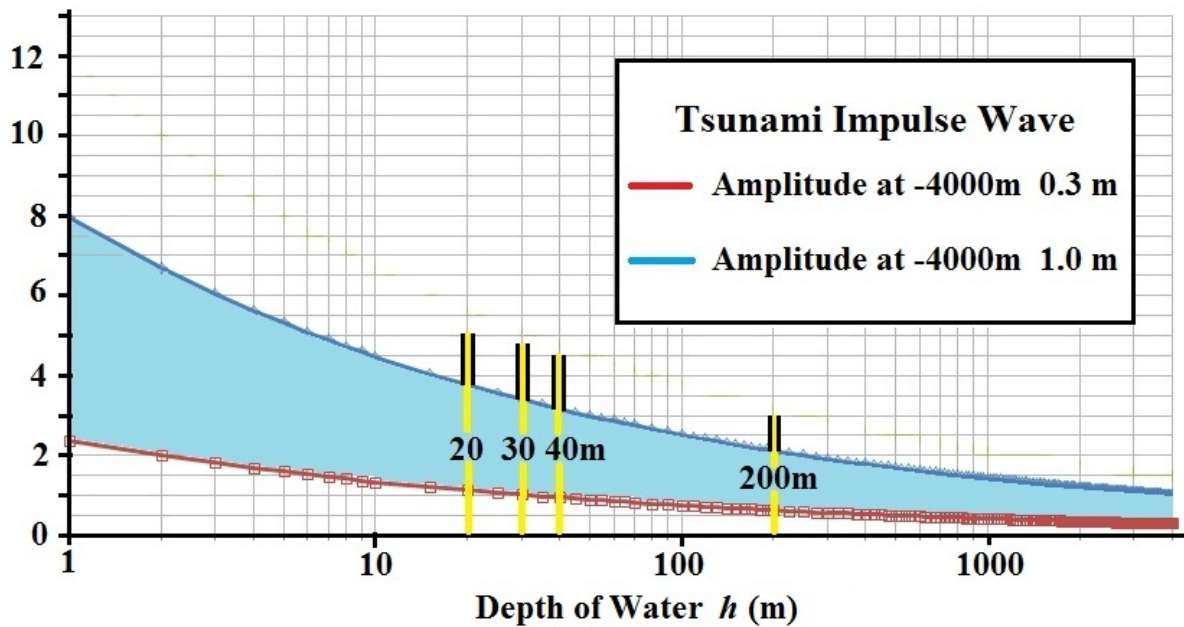
with  $g$  being the gravitational acceleration and  $h$  the water depth and is given in **Table 1** for initial tsunami wave heights at 4000m ocean depth of  $A_1 = 0.3$  m and  $A_2 = 1.0$  m. The correspondingly increased amplitudes or wave heights  $A$  follow from the constant product of squared amplitude and wave speed  $c$ :

wave speed  $c$ :

$$A_2 \times c = \text{constant}$$

and are shown as function of water depth  $h$  in Fig. 2 for the two examples of original wave height of  $A_1 = 0.3$  m and  $A_2 = 1.0$  m. In this figure the positions of proposed tsunami barriers are indicated for depth below mean sea level of 20m, 30m, 40m and 200m. The highest safety is achieved with the 200m deep barrier, but this requires great construction efforts and material transport. The following treatment will be based on the economic TFB barrier of 30m depth, which for most coastlines will give sufficient protection. If from historical studies and geophysical research larger initial tsunami impulse waves cannot be excluded, then TFB of greater depth have to be considered. Also in case of the rare coincidence of a mega-tsunami with a cyclone a wall height of 50m would be preferable.

### Tsunami Amplitude $A$ (m)



**Figure 2. Tsunami Wave Height  $A$  caused by Depth of Ocean  $h$ , with proposed Tsunami and Flooding Barriers**

Breakwaters with different configurations (Takahashi 2002) have preferably been built near the coast or within bays so that they had to withstand the enormous forces of the tsunami wave fronts and of storm surges. A large fraction of breakwaters are composed of caissons sitting on rubble mounds or foundations. Despite theoretical and experimental studies such breakwaters frequently failed because the caissons slit or tilted (Takahashi et al. 2000). A prominent example is the Kamaishi breakwater

which had been celebrated, after 31 years of construction at cost of 1.3 billion USD, as the world's largest breakwater for the Guinness Book of World Records in 2010. In the 2011 Tohoku Tsunami it failed so that the harbor and the lower part of Kamaishi city were partially destroyed and caused about 1000 fatalities. Besides non-optimized design with caissons on large foundation mound, the slopes on both coastal sides of the breakwater caused the development of large tsunami wave-fronts which was further enhanced by the funneling or focusing effect of the Kamaishi Bay. It will be shown below that a tsunami-flooding barrier to be erected outside the bay would provide safety at significantly lower cost and definitely prevents the funnel effect to increase the tsunami power. If the barriers are not too far from the shore then also the rolling effect of large sea waves from storms will be reduced and thus partially attenuates these waves. Navigation can be arranged by gates in the barrier, which can be closed upon warnings for tsunamis, storm surges or oil-slips .

**Table 1. Tsunami Wave Heights and Wave Velocities**  
for original Tsunami Speed of 713km per hour at Ocean Depth of 4000 m

<b>Water Depth</b>	<b>Speed (km per hour)</b>	<b>Wave Height</b>	
<b>4000 m</b>	<b>713</b>	<b>0.30 m*</b>	<b>1.00 m**</b>
<b>200 m</b>	<b>160</b>	<b>0.63 m</b>	<b>2.11 m</b>
<b>40 m</b>	<b>71</b>	<b>0.95 m</b>	<b>3.16 m</b>
<b>30 m</b>	<b>62</b>	<b>1.02 m</b>	<b>3.40 m</b>
<b>20 m</b>	<b>50</b>	<b>1.13 m</b>	<b>3.76 m</b>

**\*Assumed typical value**

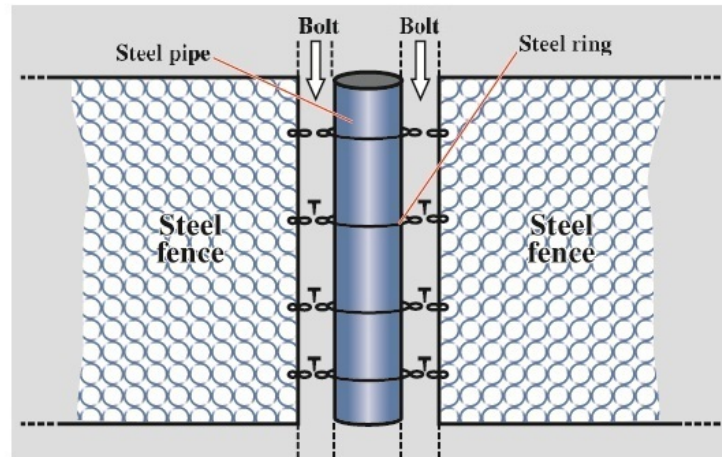
**\*\*Assumed high value**

### **Construction of Tsunami-and Flooding Barriers**

Deep-sea construction of barriers is quite demanding - but in principle possible by applying special types of saltwater-resistant concrete. The recently invented novel submarine architecture allows to build above the mentioned stable tsunami and flooding barriers (TFB) very efficiently at relatively low cost. The main components are high-strength steel fences and rocks, which can be used, in the three different technologies described in the following section. In all cases the seafloor has to be dredged to remove soft material to sufficient depth to either introduce the steel pipes and the barrier directly or to form a foundation onto which the barrier can be placed. Divers observe the process, by video cameras, or by remotely operated vehicles (ROV), or by autonomous underwater vehicles.

In the first technology a single high-strength steel fence with attached horizontal anchors is inserted into the sea and fixed at the sea floor as shown in **Fig. 1**. Simultaneously rocks are inserted which stabilize the steel fence and keep it in vertical position. The horizontal connection of the steel fences is achieved by vertical steel pipes, preferably filled with concrete, which are first inserted into the ground. The steel fences are fixed to the pipes by ring hooks and bolts, as shown in **Fig. 3**. These pipes facilitate repair, if required, by introducing new fences in front of the barrier and connecting

them. However, with a proper type of steel and wire thickness, a minimum barrier life of hundred years can be expected. Instead, the pipes strong steel profiles can be used for horizontal fence connection. The rocks should have edges and corners in order to minimize their moving in the future. The rocks can further be stabilized by inserting gravel or sand, or by inserting horizontal steel fences every three to five meters, deposited to rock thickness. Furthermore the settling of the rocks can be accelerated by vibration, for example by hitting the sides of the wall with heavy weights.



**Figure 3. Steel pipes with rings, hooks and bolts for horizontal connection of steel fences, schematic front view**

The second technology is based on two parallel steel fences with distance holders which are simultaneously inserted into the sea and which again are stabilized with rocks inserted from the top into the gap between the fences. Also these fences are horizontally connected by vertical steel pipes, rings, hooks and bolts. These double-fence barriers will be important to build large sea reservoirs for applications like tidal energy generation, hydroelectric energy storage and fish farming, as discussed below.

In the third technology large elongated gabions, baskets of steel fence filled with rocks, are pre-fabricated before they are inserted into the sea to erect a horizontally long vertical compact barrier. Steel ropes horizontally and vertically connect these gabions in order to prevent their sliding or tilting as observed with caissons of breakwaters.

Large amounts of rocks are needed in view of very long tsunami-flooding barriers such as those with depth below 30m and extension of 8m above sea level and a thickness ranging from 5.6m to 20m. Rocks can be obtained from a nearby quarry which, after being removed and created cavities can be used to form a large reservoir for hydroelectric energy storage as discussed below. Other filling materials are rubble, industrial waste, concrete blocks etc. An alternative filling could be obtained by dredging gravel or sand from the seafloor, and in this case the outflow from the barrier has to be prevented by steel plates or by saltwater-resistant fabric inside the steel fences.

All metal components of the barrier like fences, pipes, rings, ropes should have the same

composition in order to prevent electrolytic reactions and corrosion. Saltwater-resistant steel, for example, low-carbon steels with high chromium and molybdenum concentration, possibly also containing niobium, will be used, for example US steel 316L/316LN or European steel with numbers 1.4429, 1.4462, 1.4404 or 1.4571 (V4A). Besides being corrosion resistant, these steels have the advantage of a very high tensile strength. The wire thickness of the steel fences should be 3mm to 4mm. The fences should have a certain elasticity depending on their local application, for example in case of double fence barriers the sea-facing fence will need better performance than the fence on the harbor side. The normal fences can be produced in many countries. However, for the barrier section extending above sea level, a specially elastic high-strength steel fence is recommended to withstand the frequent storm surges, as for example the fence ROCCO of Geobruugg, Switzerland. An example of the strength of ROCCO fence is shown in Fig. 4 where falling rocks were stopped. The stability of the steel-fence-rock barriers can be increased by steel ropes, chains or steel beams crossing in front of the barrier and being attached to the steel pipes and to the fences.



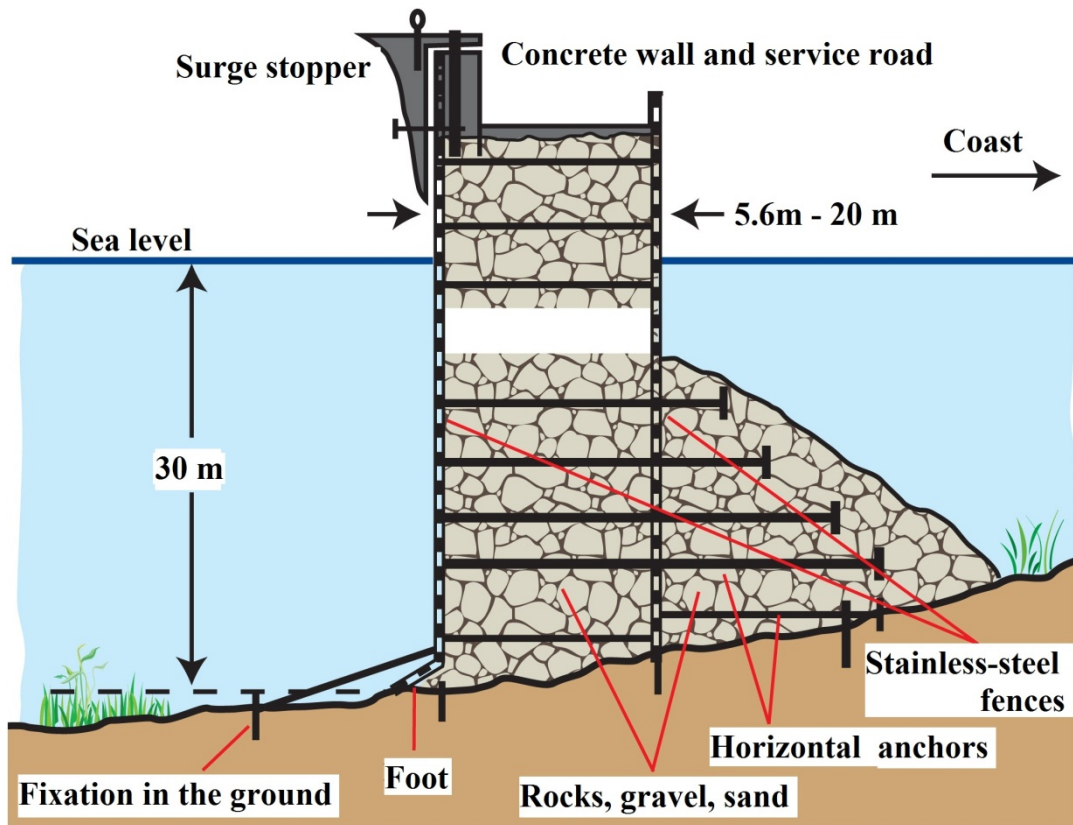
**Figure 4. Landslip stopped by high-strength steel fence**

Geobruugg Switzerland 2006

On top of the steel-fence-rock barrier, a concrete road (Fig. 5) will be of advantage and serve first in the construction phase as supply road and later as control and service road, which also may be opened for the public. This road is protected against sea waves by concrete walls, a wall of at least 1m, and better than 2m thicknesses on the seaside. Steel beams extend out of this concrete wall and hold surge stoppers (parapet) in order to reduce overtopping by storm waves and to prevent erosion of the upper part of the TFB and of the concrete wall (Scheel 2013a, 2014a,b). These surge stoppers of typically 5 m length are transported by means of hooks and are fixed at the upper beam and also at the

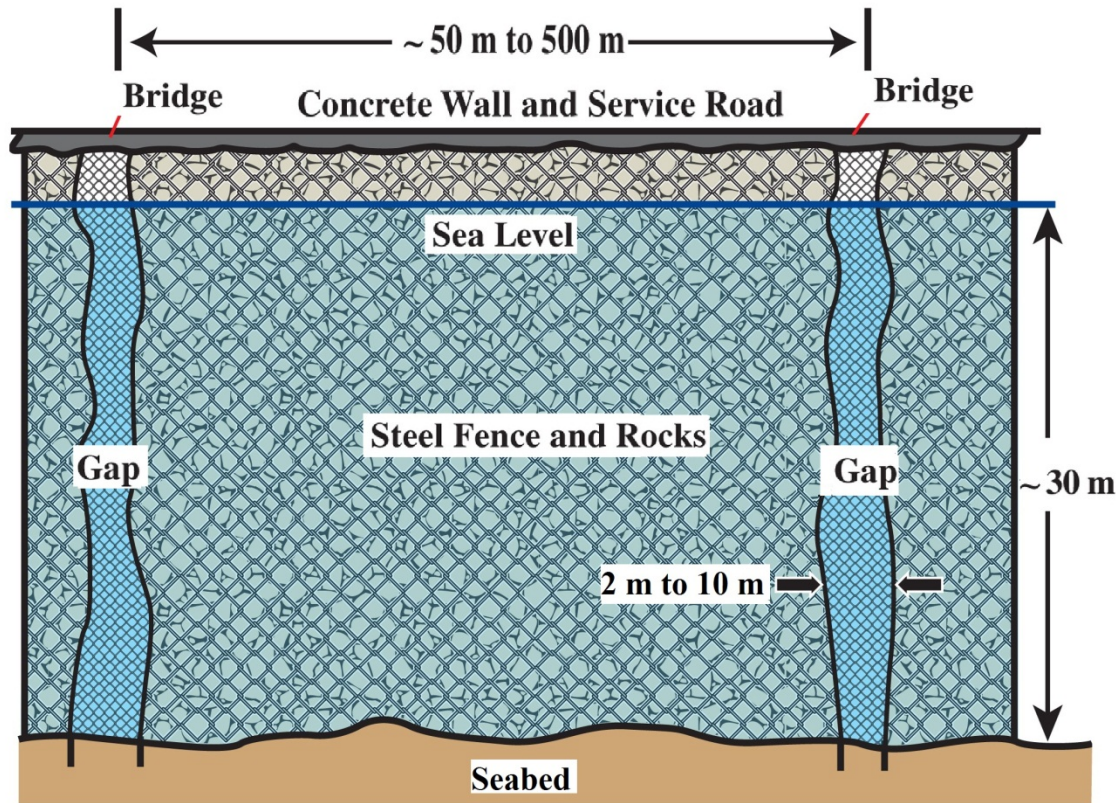
lower end to the TFB. The advantage of these surge stoppers is that they can be replaced, an advantage compared to the earlier proposed fixed “bullnose”, “wave return wall” or “recurve” (Kortenhaus et al.2003, Daemrich et al. 2006). A cross section of a tsunami-flooding barrier with service road, concrete walls and surge stopper is shown in **Fig. 5**. The double-fence barrier filled with rocks is further stabilized on the harbor side with rocks stabilizing the horizontal anchors. This barrier has a height below sea level of 30 m and has a thickness between 5.6 m and 20 m. The indicated foot reduces scouring, the removal of sand or gravel from below the barrier by sea currents.

Earthquakes or collision by large ships may cause local damage or destruction with the consequence that repairs of the barrier may require great efforts. In order to reduce the complexity of repair, weak spots like gaps may be foreseen within the barrier to facilitate the repair. These gaps are covered by concrete bridges and closed with fences or nets allowing water exchange but prevent large fish to escape or to enter. This barrier with weak spots is shown in **Fig. 6**.



**Figure 5. Double - fence tsunami-flooding barrier with concrete service road, concrete walls and surge stopper, schematic cross section**

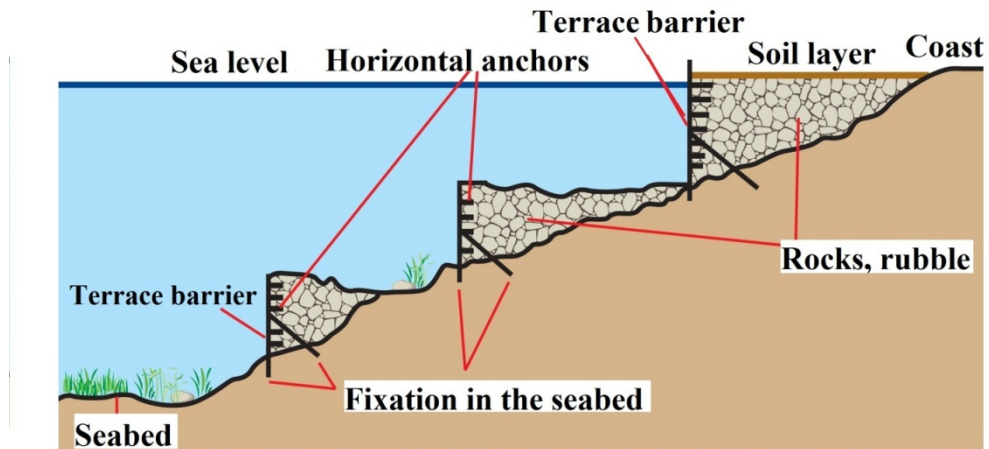




**Figure 6. Schematic front view of tsunami-flooding barrier with weak gaps covered by concrete bridges**

The surface roughness of the seaside of the barrier as well as its elasticity will determine the degree of reflectivity of the tsunami impulse waves. If for instance there would be a long flat barrier to protect Honshu island of Japan, the reflected impulse waves could travel across the Pacific Ocean and hit Canada and the US. In order to prevent this the barriers could have an angle slightly tilted downwards to reflect in the direction of the Japanese trench, or slightly upward to transform the kinetic energy of impulse waves partially to potential energy to form normal water waves. Otherwise the rough surface of the fence-rock structure will reduce reflectivity and assist to dissipate a significant fraction of the tsunami energy. These described aspects require further investigations for validation.

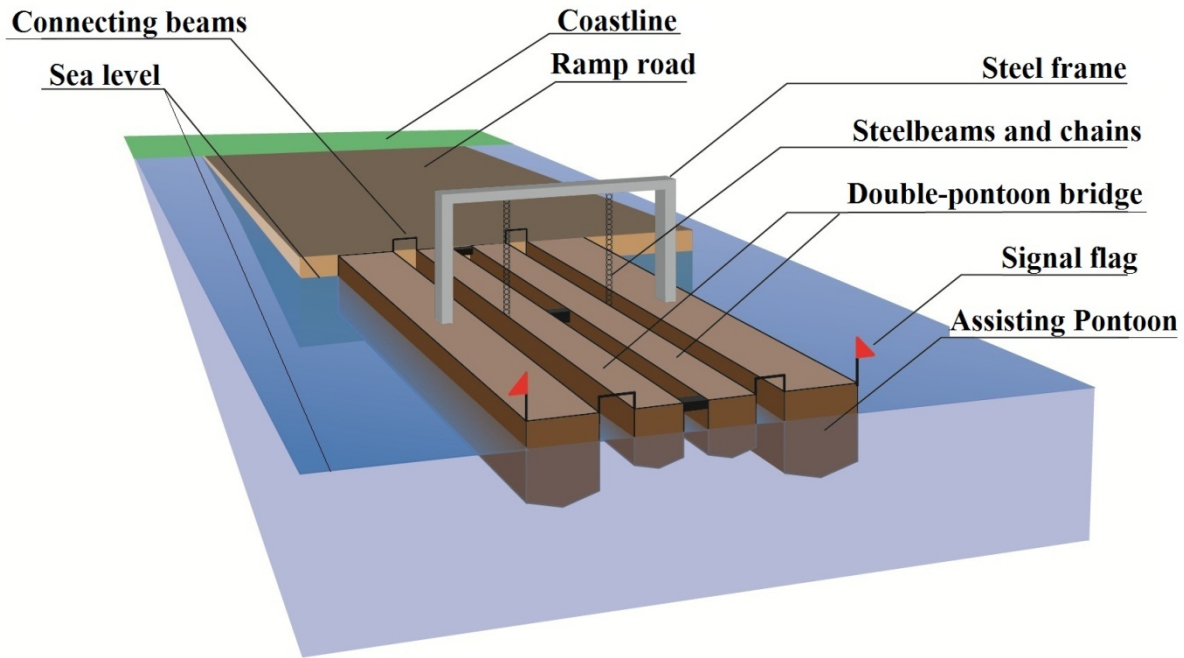
The height of the tsunami-flooding barrier may be divided in order to save rock material and steel fence (Scheel 2013a, 2014a,b). The terrace barrier shown in **Fig. 7** built by single-fence technology and horizontal anchors fixed by rocks nevertheless allows to reclaim new land.



**Figure 7. Schematic cross section of a tsunami-flooding barrier in terraces in order to save rocks and for land reclamation**

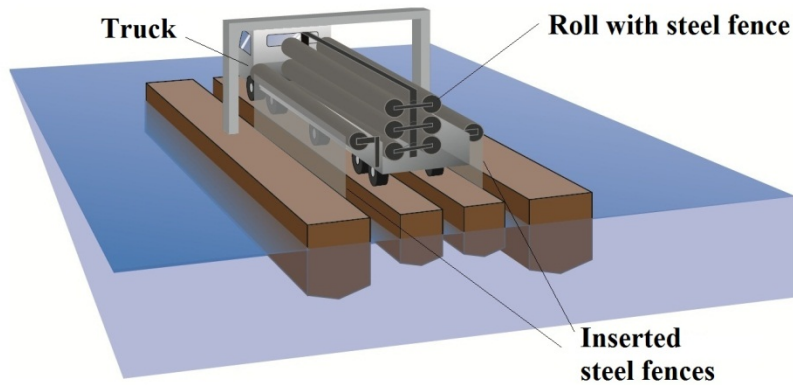
### **Double-Pontoon Technology**

Depending on the slope of the continental shelf, the position of 30m-deep barriers will be far out in the sea so that construction of stable vertical walls - including transport of fences, rocks and concrete and working from ships - will be very demanding and only possible at a relatively quiet sea. A relatively simple and efficient technology was invented which facilitates the erection of tsunami-flooding barriers (Scheel 2013.b, 2014.b) whereby the sea waves are damped. First at the coast a stable ramp road is built with sufficient depth so that two parallel pontoons can be attached. In order to carry the heavy loads of trucks with steel-fence rolls and with rocks, these middle pontoons are connected with large external assisting pontoons by means of a steel frame and hanging on steel chains as shown in **Fig. 8**.



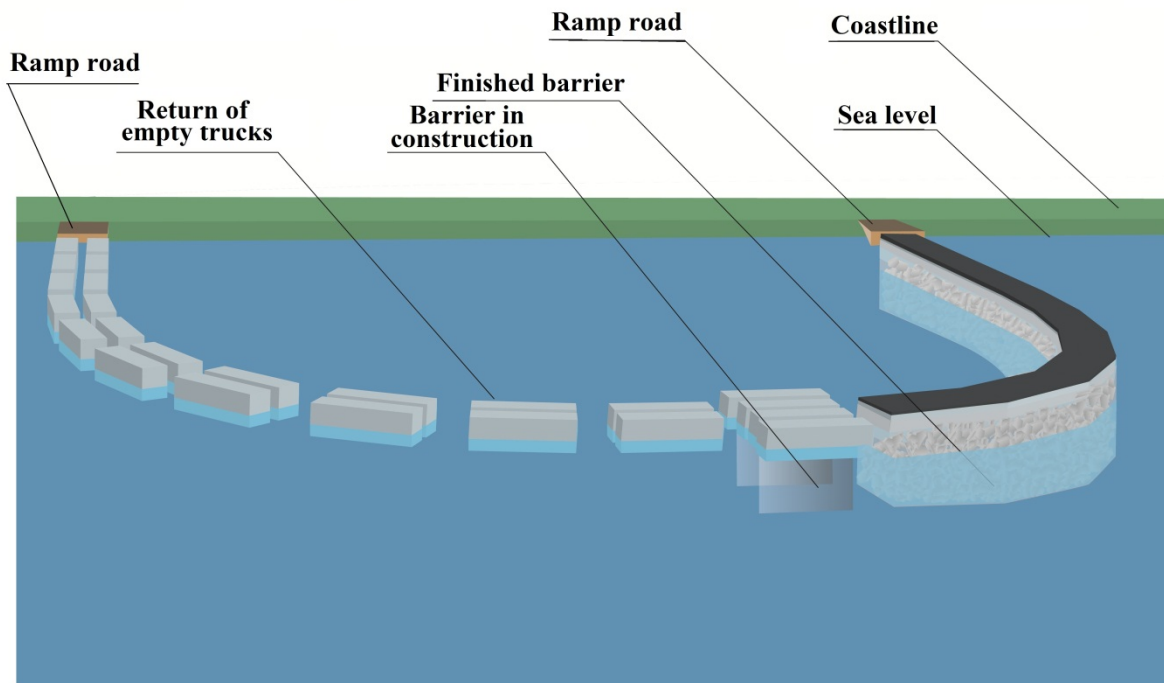
**Figure 8. Double-pontoon connected with the land by a ramp road. Assisting pontoons increase the load capacity, schematic view.**

Furthermore the central and peripheral pontoons are connected by steel beams in the middle and at the end and thus allow to lower steel fences in the gap between central and assisting pontoons and between the fixation steel beams. The latter coincide with the position of the vertical steel pipes, which are lengthened after the concrete road is finished. Trucks with rolls of steel fences move onto the central double-pontoon and insert the fences on both sides as shown in **Fig. 9**.



**Figure 9. Schematic view of a truck on a double-pontoon bridge simultaneously inserting two steel fences into the sea.**

This process is followed by trucks filled with rocks, dropping their loads through an opening of the truck into the gap between the two central pontoons. For rock sizes in the range 30cm to 80cm the openings of the truck and of the pontoon gap should both be about 1 m. Now the pontoon fleet has to move on to the next building site so that the top of the TFB can be completed by filling with rocks from ships or rocks transported with trucks using conveyor belts, followed by special trucks to deliver concrete and reinforcement steel to build the top concrete road and the concrete walls on both sides of the road. The empty trucks return or move over the solidified concrete road via double or single pontoons to the coast, as schematically shown in **Fig. 10**. The fresh concrete road can also be passed on temporary or permanent platforms on top.



**Figure 10. Schematic view of double-pontoon bridge at the construction site, with finished tsunami-flooding barrier to the right. After delivery of steel fence and rocks, the trucks return to the coast on single-pontoon or on double-pontoon bridges to the left.**

Most of this barrier construction work will be done in seasonal periods of few storms, as for instance in the summer. However, one has to be prepared for storms with waves up to 10m or even higher. Wave attenuation is achieved by large-area stable steel fences floating on the sea by pontoons which are fixed on the seafloor by foundations, anchors, and/or by heavy weights connected by steel chains and steel beams (Scheel 2013b, 2014b). The optimum size (typically between 100 and more than 500m in both horizontal directions) and the water permeability, defined by the openings of the fence, have to be optimized for the specific sea area. The costs of such wave attenuators including fixation may pass 10 million USD, but the fences can be re-used and also be applied in other areas like harbors. These costs can be reduced for temporary wave attenuation by replacing steel fence by wood or polymers with openings. However, these horizontal wave attenuators will not help to stop the tsunami waves, but some wave attenuation can be achieved by vertically hanging steel fences fixed in the bottom of the sea.

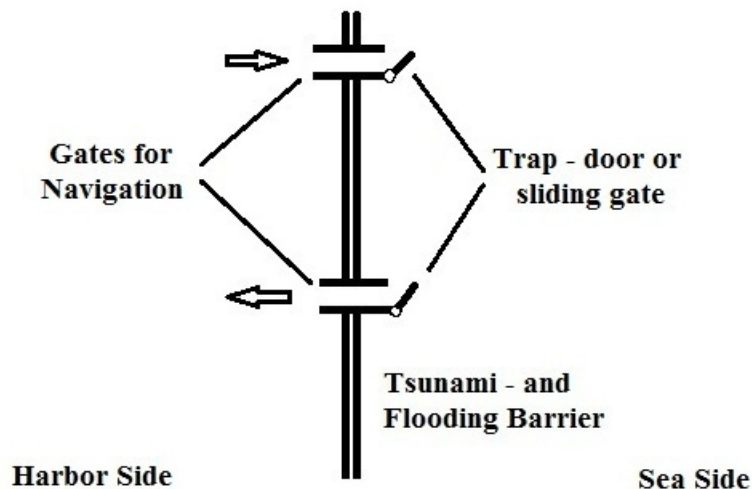
### **Cost Estimates**

The protection of coastlines by these new TFB barriers requires tens or even hundreds of km of their length so that such large projects become the obligation of governments, UN Organizations, World Bank, or they can be considered by insurance companies or by wealthy investors or sponsors.

For example to achieve tsunami protection for the Honshu/Japan coast from Tokyo to the north requires 800km, and to protect Tokyo/Yokohama, Shizuoka, Hamamatsu and Nagoya 600 km with large barrier depth variations are needed. A first preliminary cost estimate for 1km normal TFB with 30m depth and 5.6m-wall thickness is given in **Table 2**. Not included are the costs for navigation openings and lockable gates, which are schematically shown in **Fig. 11**.

**Table.2. Estimated costs for 1km tsunami barrier 5.6m wide x 33m depth with supply/service road and with surge stoppers (US 2013 prices)**

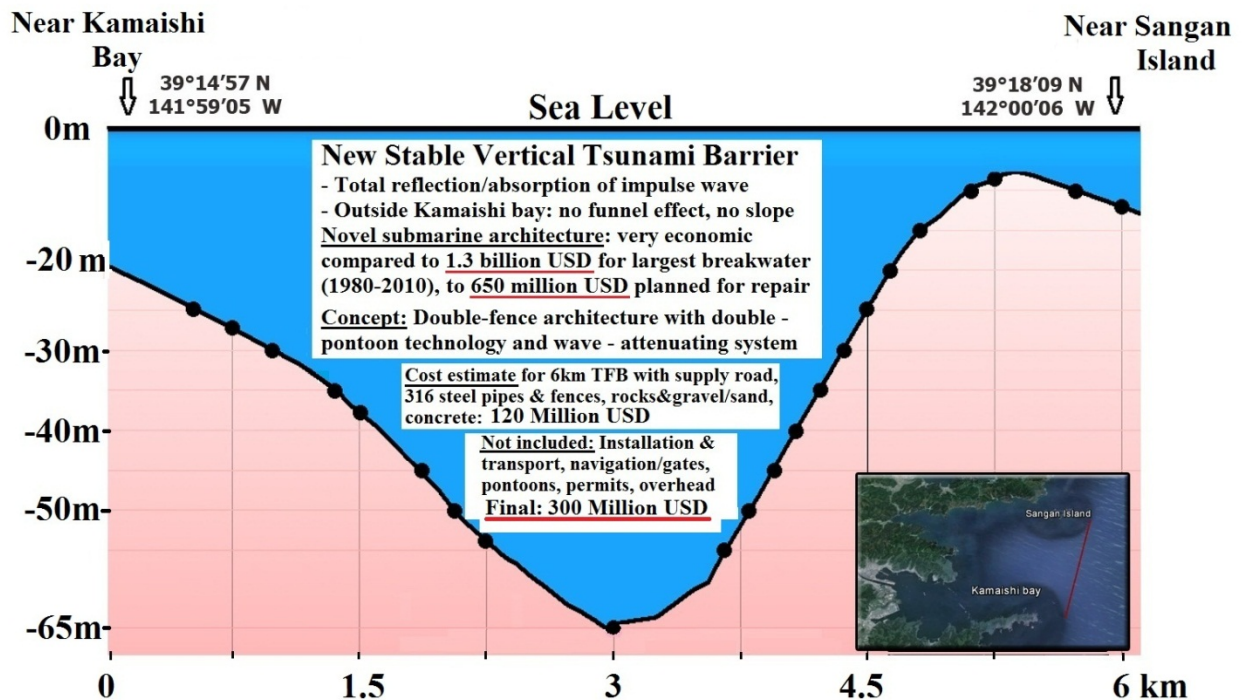
-	Rocks with density 2.7 and 20% void: 400'000 tons (5600 truck loads à 71 tons); 150'000 m <sup>3</sup> à 10 USD	<b>1'500'000 USD</b>
-	Concrete for supply/service road, concrete walls, surge stopper 6'000m <sup>3</sup>	<b>600'000 USD</b>
-	Road construction with reinforcement, sub-base, grading, steel beams etc.	<b>250'000 USD</b>
-	300 Stainless steel pipes T-316 (17cm OD, 7mm wall, 40m)	<b>3'000'000 USD</b>
-	Steel fences 70'000m <sup>2</sup> à 50 USD (eg. QUAROX + ROCCO, Geobrug)	<b>3'500'000 USD</b>
-	Share of pontoons, dredging, design & stability analysis, diverse costs	<b><u>2'150'000 USD</u></b>
	Total for 1km	<b>~11'000'000 USD</b>
	<b>With overhead, insurance and unexpected costs</b>	<b>&lt; 20'000'000 USD</b>



**Figure 11. Schematic top view of navigation gaps in TFB barriers for inward and outward traffic, with gates to be closed upon tsunami, storm or oil-spill warning**

The Maldives, the North Sea islands (Halligen) of Germany and many other threatened islands can be protected against tsunami or directional storm waves by barriers facing the critical direction. But for protection against increased sea level caused by the climate change, the whole islands have to be surrounded by TFBs and navigation gates or sluices.

In the following section two specific protection systems will be discussed along with preliminary cost estimates. A practically definite protection of Kamaishi can be achieved by a barrier outside the bay where the funneling effect of the bay is prevented and where the catastrophic tsunami waves have not yet developed, as this is shown in the self-explanatory **Fig. 12**. It should be noted that the costs are less than 25% of the original Kamaishi large breakwater costs and less than half of its planned repair costs (of which the effectiveness against large tsunami is doubted).



**Figure 12. Depth profile in front of Kamaishi Bay with cost estimate for 6km tsunami-flooding barrier not including navigation gates**

The second example is a barrier to protect the New York Bight, which had been terribly affected by hurricane Sandy, see **Fig. 13**. The 42km barrier outside the bay would cost less than 2% of the estimated 65 billion USD damage of Sandy whereby the 286 fatalities are not considered. However with the large lockable gates for the significant navigation the total costs of the barrier may double. These barrier installation costs may eventually be at least partially compensated by the applications discussed below.

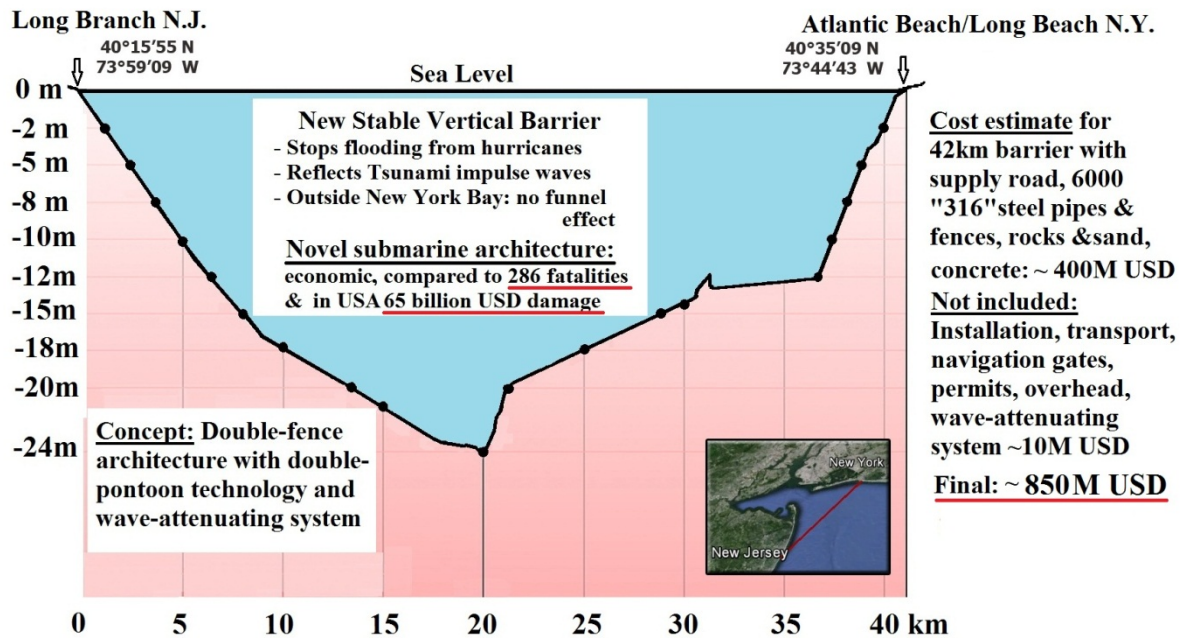


Figure 13. Sea depth profile in front of New York bight with cost estimate for 42km tsunami-flooding barrier crossing the bight, where navigation gates are not included

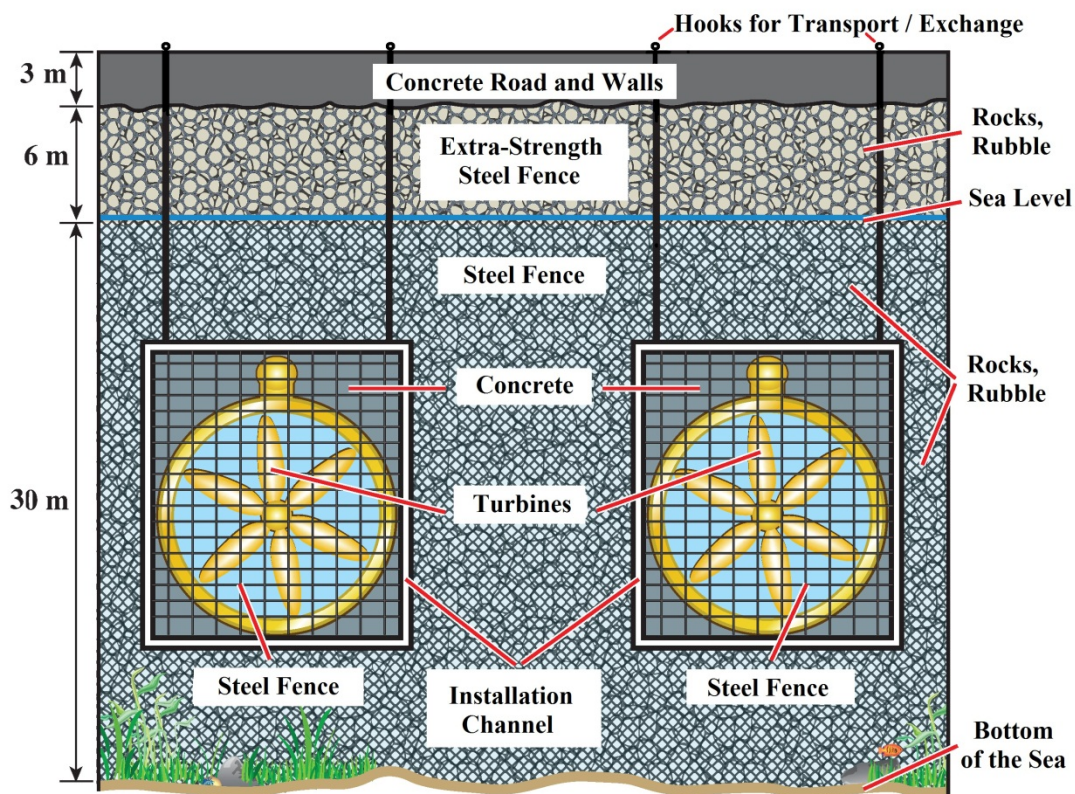
### Applications of Tsunami- and Flooding Barriers for Tidal Energy and for Fish Farming

In addition to protecting coastlines against tsunami and storm surges, there are several important application possibilities by using the large sea reservoirs between barrier and coast. A first example is **reclamation of land** which will be significant for Japan, as demonstrated by the lowest price of land being already 100 USD per m<sup>2</sup> whereas for the United States it may be of interest only near the large cities (which however need flooding protection). Filling the gap between barrier and coast has been shown in **Fig. 1** and in **Fig. 7**. A large variety of material can be used to fill up this gap, the simplest being sand and gravel from dredging from the seaside of the TFB. Other material to be deposited will be rocks, rubble, debris etc. Furthermore, the large gap may be used as dump when proper precautions are taken and controlled to protect groundwater and sea from contamination.

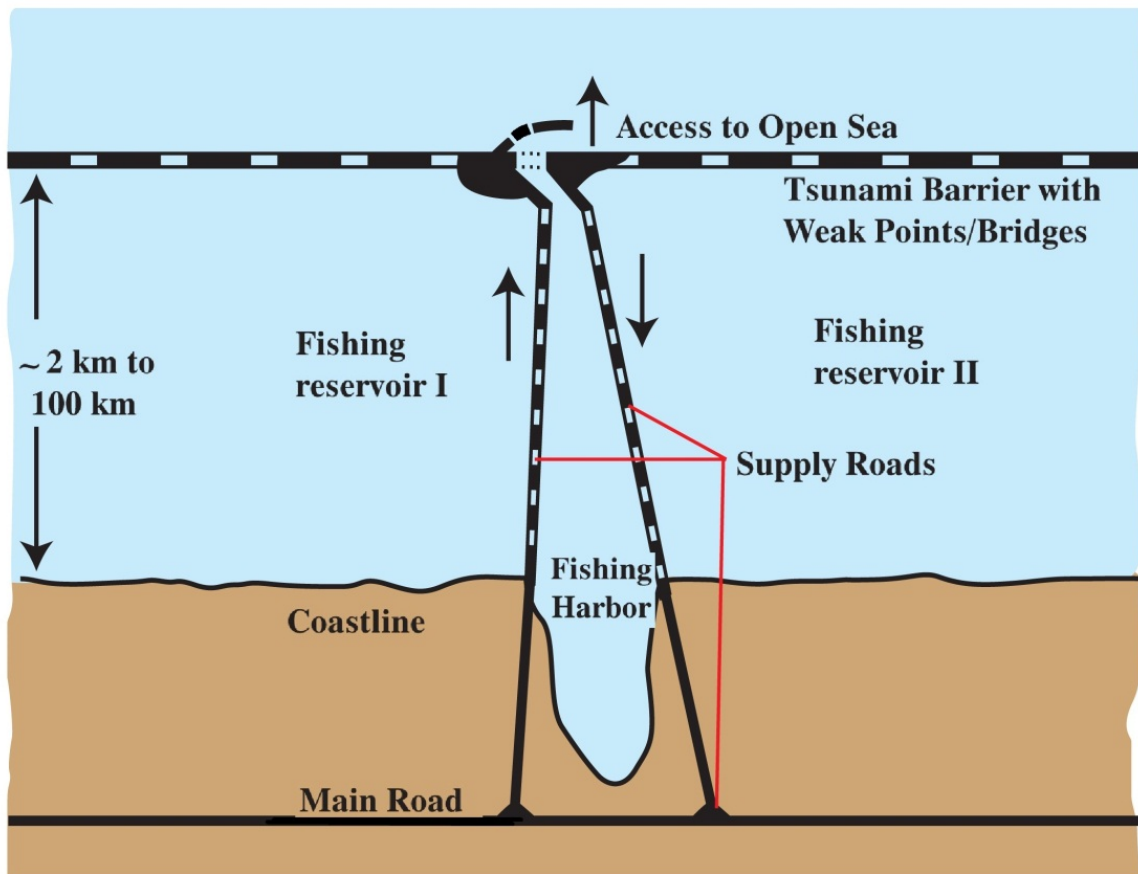
A significant relief of the world's nutrition problem will be achieved by using the huge reservoirs between barrier and coast for **fish farming**, preferred in combination with **tidal energy generation**. Overfished species like bluefin tuna could be reproduced there. Turbines built into the barriers could generate electricity and at the same time exchange water with each tide so that always oxygen-rich sea water is available for the fish. In this combination even a low tidal energy efficiency from small height changes may be worthwhile. Turbines inside the TFB barrier are schematically shown in **Fig. 14**. Certain installation parts are produced or protected by copper alloys to prevent fouling, however these alloys should not get in contact with the stainless steel fences in order to prevent electro-corrosion.



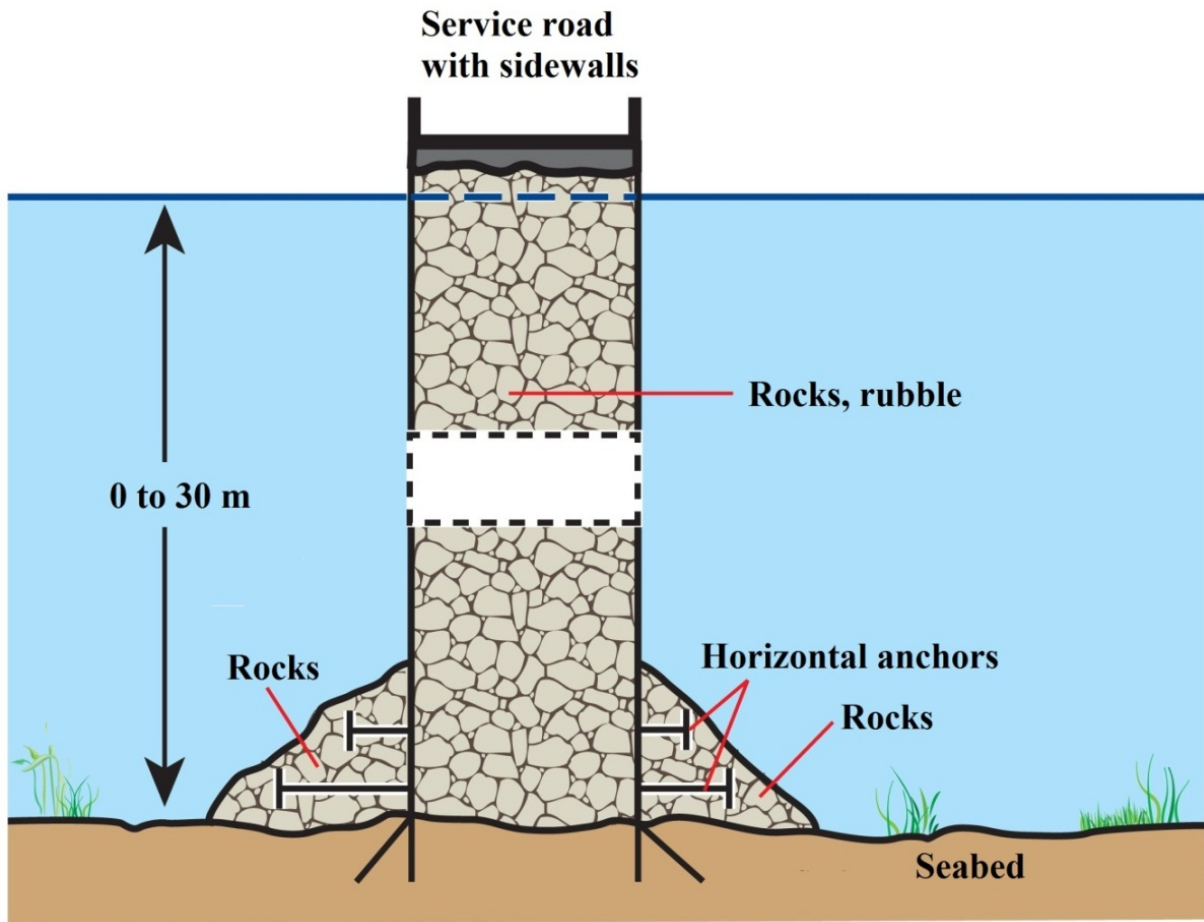
The size of the reservoirs allow their division them into sections for different fish sizes, to move the fractions of fish sizes from section to section, and to harvest the final size at the last section. Supply roads separate large fishing reservoirs and allow navigation from the fishing harbor to the open sea as shown in **Fig. 15** where a short horizontally inclined vertical barrier **prevents** propagation of tsunami waves. An example of a supply road is shown schematically in **Fig. 16**, the concrete walls are of reduced thickness, and surge stoppers are not needed. All openings to the open sea can be locked by gates in case of tsunami warning or oil-spill warning



**Figure 14. Turbines inside the tsunami-flooding barriers for tidal energy, schematic front view**



**Figure 15. Schematic top view of fishing reservoirs, supply roads, and of fishing harbor with access to the sea**



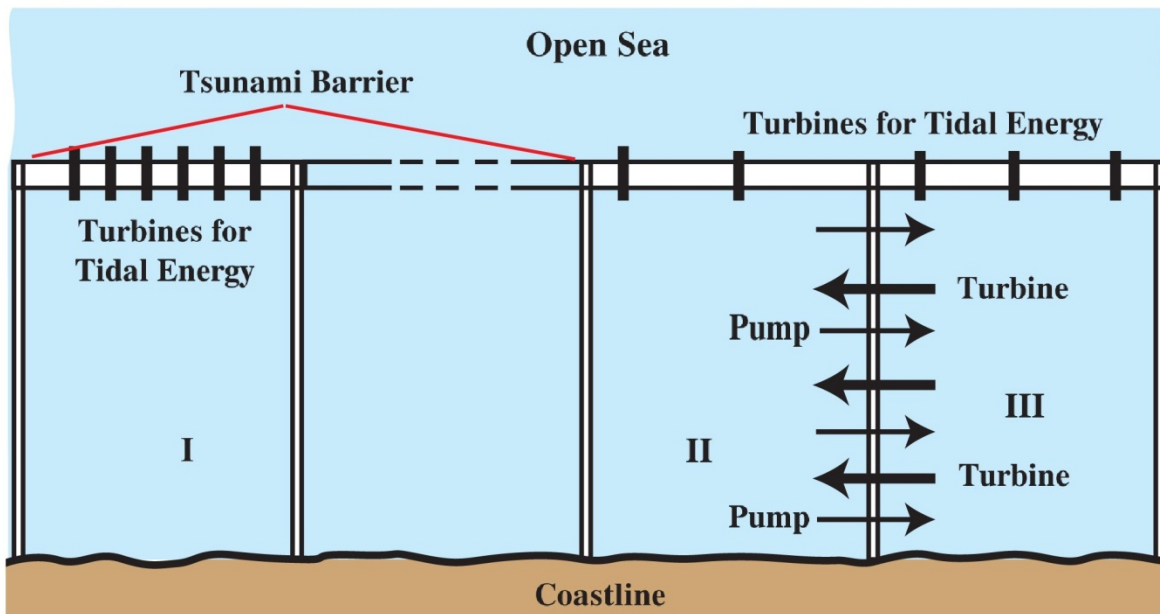
**Figure 16. Schematic cross section of a double-fence barrier with supply road between tsunami-flooding barrier and coast. The road has a width between 3 m and 5 m.**

### **Applications of TFB Barriers for Pumped Hydroelectric Energy Storage**

The storage of energy is a widespread problem, which will increase with the development of wind, and solar energy, which inevitably is intermittent. So far, most important hydroelectric energy storage with lakes filling the valleys is approaching its limit due to geographic limitations and to the resistance of people which have to be dislocated. A barrier system for a successful combination of tidal energy and pumped energy storage was installed in Rance, Northern France in 1967, has a capacity of 240 MW, and is still generating electricity for stabilizing the grid. Nevertheless, the use of barriers in the sea has been hindered by their reputation of high construction costs. This may change with the new technology presented in this paper. The new sea reservoirs offer practically unlimited storage capacity, especially when they are arranged at the coasts near the large cities in combination with flooding protection. **Fig. 17** shows a schematic top view of large sea reservoirs, I for tidal

energy, and II and III for hydroelectric energy storage where water is pumped with low-cost surplus electricity from II into the storage reservoir III to an upper level of say 12m to 15m. Turbines generate electricity by the potential energy when needed by using the higher water level in reservoir III. A larger potential energy difference can be achieved when a quarry in a nearby mountain or at an elevated site is established in order to produce rocks for building the TFB barriers and at the same time to provide a hydroelectric storage reservoir at a higher level. Here either the rock itself establishes the barrier for the “rock reservoir”, or a barrier is built with fence-rock architecture. Instead of separated pumps and turbines there are advantages with recently developed combined pump-turbines.

A specific application of TFB barriers could solve the **Fukushima-reactor problem** of radioactive water. Large separated reservoirs in the sea with concrete bottom could take up the contaminated water in the first reservoir; pass water through a decontamination stage to the next reservoir and so on until the water of the final reservoir can be released through a long pipe into the Japan trench respectively into the Kuroshio current. This last water may still contain tritium which has a short lifetime, is anyhow found in natural water, and which thus cannot be detected after dilution in the sea.



**Figure 17. Reservoir I for generating tidal energy, and reservoirs II and III to achieve hydroelectric storage energy by pumping, are seen in this schematic top view**

### **Protection of Submarine and Off-Shore Buildings by Fence- Rock Architecture**

With expected higher sea level due to climate change and with higher intensity of tropical storms the risks for offshore platforms, for wind farms and for bridge pillars will increase. Single-fence-rock structures and double-fence-rock structures used for the TFB barriers will, with geometric modifications, also protect submarine and offshore installations (Scheel 2013a, b, 2014a, b). The

construction is done in analogy to the TFB construction: annular connected fences or double fences with distance holders are filled with rocks or other solids to build a massive wall for protection. The thickness of the structure and the height depend on the maximum possible waves and the maximum expected collision from ships or floating bodies. In general one can expect that a thickness of 1m to 5m around the platform pillars or around the whole platform or around bridge pillars will be sufficient, and the height above sea level may be in the range between 2m and 10m.

An interesting aspect is the possibility to efficiently build **roads into the sea**, for instance to near-shore islands, platforms or wind-farms and to provide thereby reliable transmission of oil, gas and electricity.

With the 2012 discovery by Japanese scientists of rare-earth minerals near the coral reef island Minamitorishima the interest in deep-sea mining increased. Also here the steel-fence-rock architecture may become of interest as it allows to produce marking spots and lines and to construct deep-sea walls, fenced areas and buildings, which may facilitate the mining process. In general, geographic markers can be established on the bottom of the sea.

Here also, coral reef barriers should be mentioned which can be protected against tsunamis by the submarine architecture with TFB barriers to be built in appropriate distance and depth including the possibility to protect barrier reefs against oil and other contamination from the sea.

## **Conclusions**

The tsunami-flooding barriers will save innumerable lives and protect property and infrastructure and can be constructed with support of governments and organizations. The construction costs will partially be compensated by applications, which are relevant for energy and for food problems of mankind. At the same time, such big projects will stimulate and get major industries involved and thus provide job growth. Such barriers could also allow to withstand some of the oncoming problems of climate change - like sea level rise and greater intensity tropical storms - and thus may help survival for islands threatened by such changes. The new submarine architecture will also protect offshore platforms and other installations in the sea. A main aspect is that the tsunami-flooding barriers can protect fauna, flora, beaches and even coral reefs against contamination.

## **Acknowledgment**

The author thanks H. Schüttrumpf/RWTH Aachen, A.Strusinska/LWI Braunschweig and M. Toullos/NTUA Athens for valuable suggestions.

## REFERENCES

- Annunziato, A.(2007), The Tsunami Assessment Modeling System by the Joint Research Centre, *Sci. Tsunami Hazards* 26 (2), 70-92.
- Annunziato, A., Franchello, G, and Groeve,T.(2012), Response of the GDACS system to the Tohoku earthquake and tsunami of 11 March 2011, *Sci. Tsunami Hazards*, 31, 283-296.
- Arikawa T., Sato M., Shimosako K., Hasegawa I., Yeom G.S., and Tomita T.( 2012),Failure mechanism of Kamaishi breakwater due to the Great East Japan Earthquake Tsunami, in *Proc. Coastal Engineering* 33, 1-13.
- Bryant,E.(2008), *Tsunami, the Underrated Hazard*, 2nd ed. Chichester UK: Springer & Praxis Publishing.
- Burcharth H.F. and Hughes S.A.(2011), Types and functions of coastal structures, *Engng. Manual*, US Army Corps of Eng. Rep. EM 1110-2-1100 Part IV change 3, ch. 2, September 2011.
- Christian C. and Vennel R.( 2012), Efficiency of tidal turbine farms, *Proc. Coastal Engineering* 33, 1-10.
- Daemrich K.F., Meyering J., Tack G., and Zimmermann C. (2006), Overtopping at vertical walls and parapets-regular wave tests for irregular simulation, *Proc. First International Conference on the Application of Physical Modeling to Port and Coastal protection*, Coastlab Porto, Portugal.
- EPRI (2011), The Electric Power Research Institute (EPRI), Energy storage-packing some power, *The Economist*, March 3, 2011.
- Holloway G., Murty T., and Fok E. (1986), Effects of Bathymetric Roughness upon Tsunami Travel Time, *Sci. Tsunami Hazards* 4(3)165-172.
- Kortenhaus A., Pearson J., Bruce T., Allsop N.W.H., and Van der Meer J.W. (2003), Influence of parapets and recures on wave overtopping and wave loading of complex vertical walls, *Proc. Coastal Structures ASCE*, Reston, Virginia, 369-381.
- Levin, B. and Nosov, M.(2009), *Physics of Tsunamis*, Springer Science +Business Media B.V.
- Marchuk A.G.(2009), Tsunami Wave Propagation along Waveguides, *Sci. Tsunami Hazards* 28 (5) 283-302.
- NOAA/NGDC (assessed 17.7.2014), Global Historical Tsunami Database, National Geophysical Data Center, NOAA.
- Potter, N.L.(2013), “Hanging Ten”; Measuring Big Wave Intensities, *Sci. Tsunami Hazards* 32(3)195-212.
- Rauch E. (2014), Munich Re’s Perspective on Climate Change in the Light of the 5<sup>th</sup> IPCC Assessment Report, 16<sup>th</sup> Meeting of The Geneva Association’s Annual Circle of Chief Economists 26 – 27 February 2014, Munich.

- Scheel H.J. (2013), Structure and method for protection against tsunami-waves and high sea-waves caused by storms, WIPO/PCT No. WO 2013/030810 A1, March 7, 2013.
- Scheel H.J.(2013a), Submarine construction for tsunami and flooding protection, for fish farming, and for protection of buildings in the sea, EP Patent Appl. 13162698.8, April 8, 2013.
- Scheel H.J.( 2013a), Submarine construction for tsunami and flooding protection, for fish farming, and for protection of buildings in the sea, U.S. Patent Appl. 13/861, 608, April 12, 2013.
- Scheel H.J.(2013b), Double-pontoon-bridge construction of submerged barriers and of off-shore roads, WIPO/PCT Patent Appl. PCT/IB2013/059511, October 21, 2013.
- Scheel H.J.( 2014a), New type of tsunami barrier, *Natural Hazards*, 70, 951-95.
- Scheel H.J.( 2014b), Submarine construction for tsunami and flooding protection, for tidal energy and energy storage, and for fish farming, *Patent Applications in 9 countries*, February 8, 2014.
- Srivastava, A., and Sivakumar Babu, G.L.(2009), Analysis and Design of Reinforced Earth Wall for Shore Protection System against Tsunami, *Sci. Tsunami Hazards* 28(3)186-204.
- Strusinska, A.( 2011), *Hydraulic Performance of an Impermeable Submerged Structure for Tsunami Damping*, Stuttgart: IBIDEM-Verlag.
- Takahashi S.(2002), Design of vertical breakwaters, short course of hydraulic response and vertical walls, in *Proc. 28th International Conference on Coastal Engineering*, Cardiff, Wales UK, July 7, 2002.
- Takahashi S., Shimosaki K., Kimura K., and Suzuki A.(2000), Typical failures of composite breakwaters in Japan, *Proc. 27th International Conference on Coastal Engineering*, ASCE, 1885-1898.
- Vicinanza D., Stagonas D., Müller G., Norgard J.H., and Andersen T.L.(2012), Innovative breakwater design for wave energy conversion, *Proc. Coastal Engineering*, 33, structures 1, 1-12.